

שרשראות סודוקו 2

תגובות רבות ונלהבות קיבלתי על חוברת "שרשראות סודוקו" הראשונה. מוסיף פה חוברת חדשה.

הנה הסבר בשלבים ובציורים תשבץ קטן של 1 ועד 3. ברמת העיקרון. לאורך ולרוחב, צריך להיות את המספרים מ 1 ועד 3. וחוזר שרשראות שבכל אחד מהם צריך להיות מ 1 ועד 3.

זה מתחיל מצד שמאל, תשבץ ריק. וממשיך להתמלאות צעד אחר צעד! עד להשלמתו.

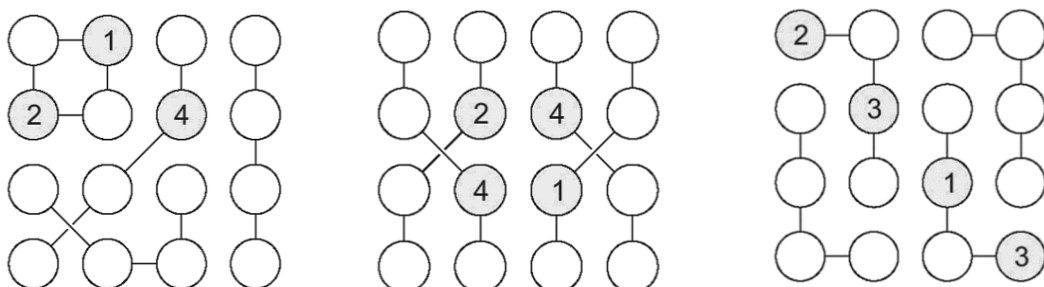
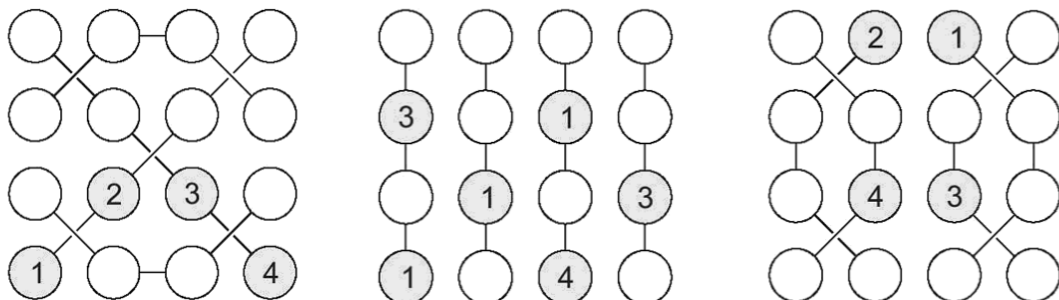
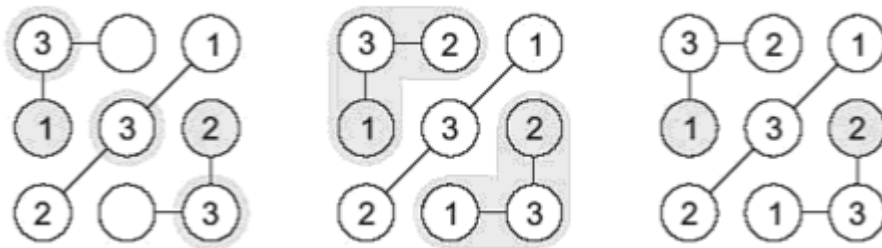
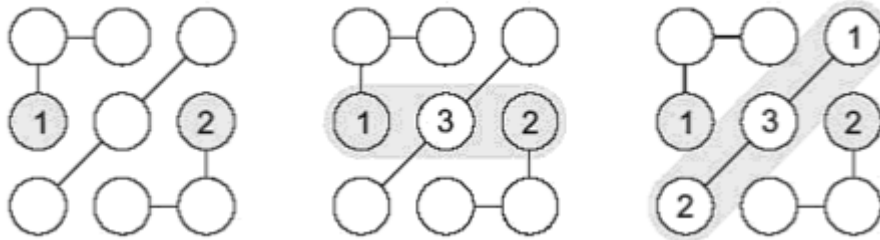

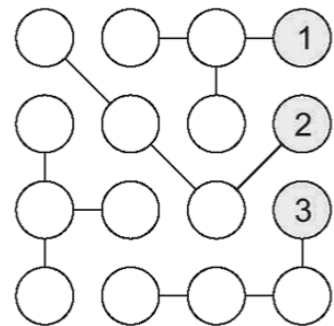
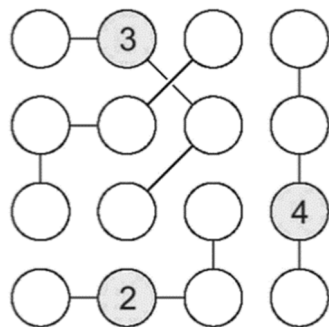
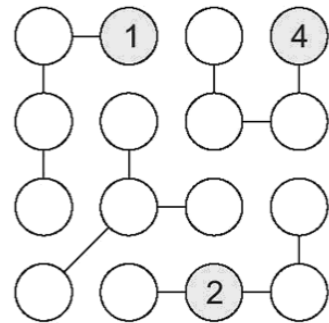
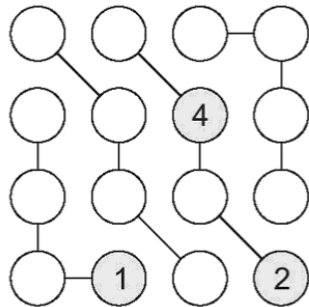
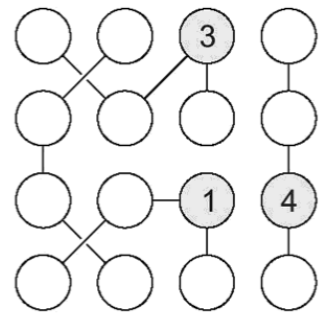
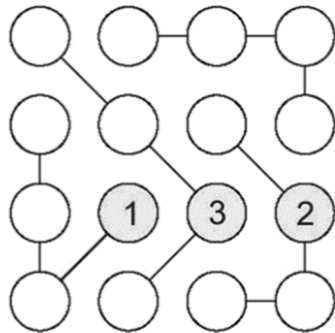
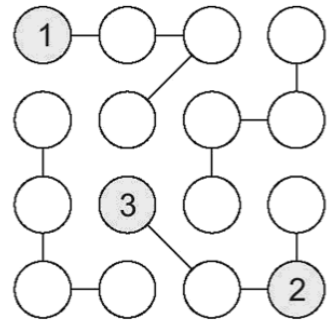
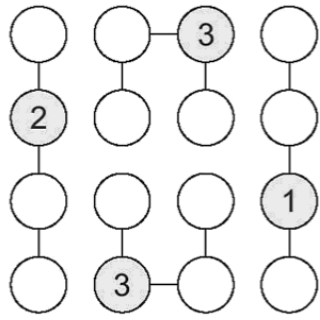

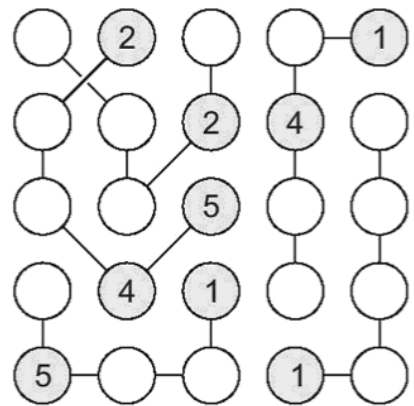
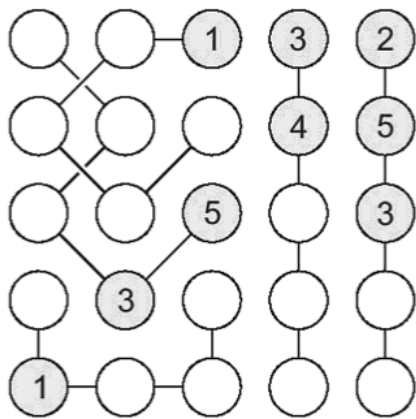
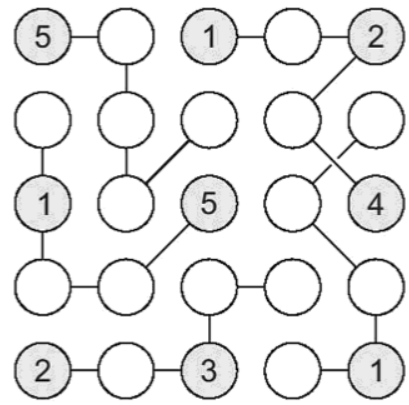
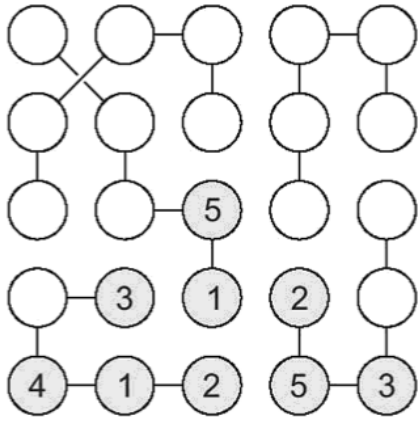
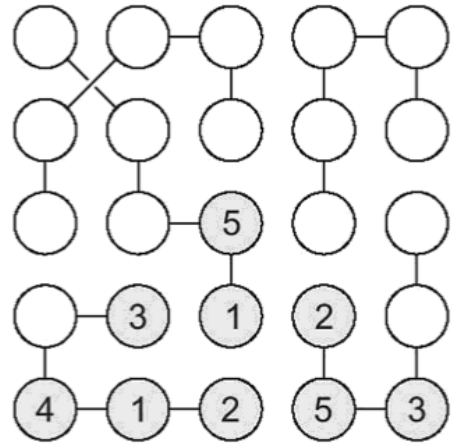
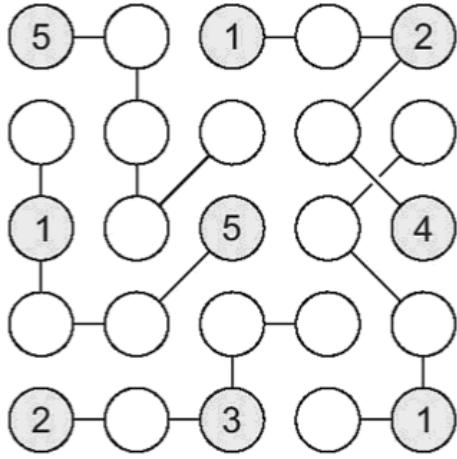

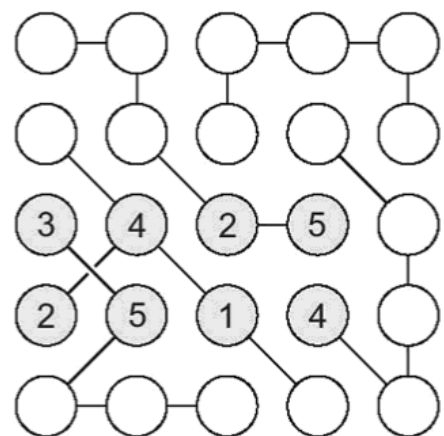
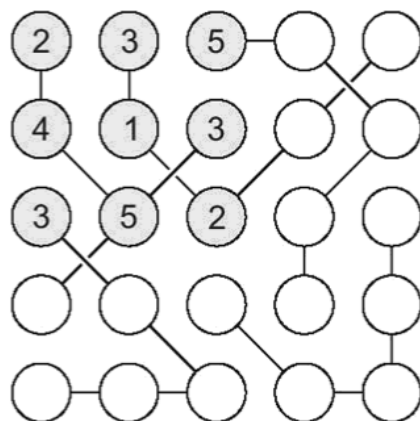
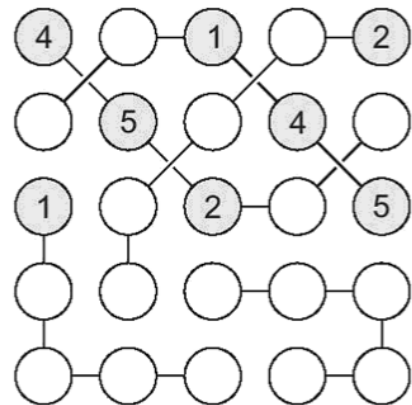
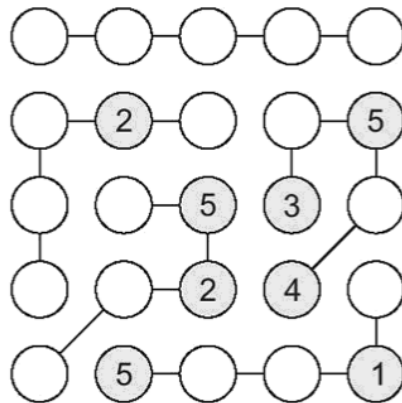
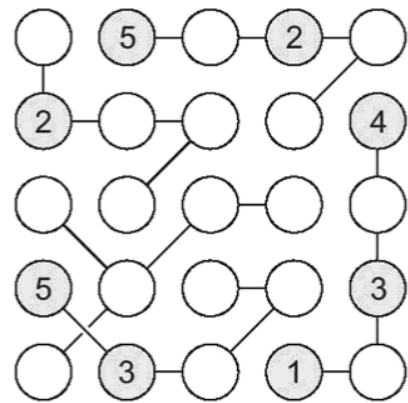
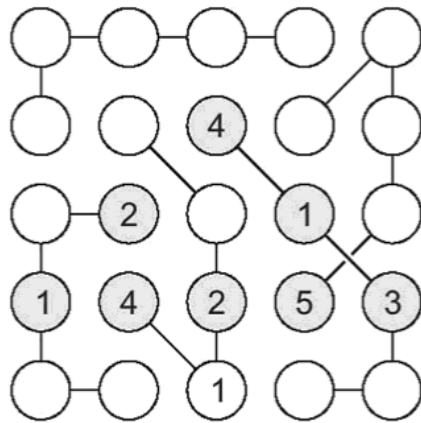

בהצלחה!